

COMPLEMENTARY OUTPUT HALL EFFECT LATCH**AH276****General Description**

The AH276 is an integrated Hall sensor with output driver designed for electronic commutation of brushless DC motor applications. The device includes an on-chip Hall sensor for magnetic sensing, an amplifier that amplifies the Hall voltage, a Schmitt trigger to provide switching hysteresis for noise rejection, a temperature compensation circuit to compensate the temperature drift of Hall sensitivity and two complementary open-collector drivers for sinking large load current. It also includes an internal band-gap regulator which is used to provide bias voltage for internal circuits.

Placing the device in a variable magnetic field, if the magnetic flux density is larger than threshold B_{OP} , the pin DO will be turned low (on) and pin DOB will be turned high (off). This output state is held until the magnetic flux density reverses and falls below B_{RP} , then causes DO to be turned high (off) and DOB turned low (on).

AH276 is available in TO-94 (SIP-4L) package.

Features

- On-Chip Hall Sensor
- 3.5V to 16V Supply Voltage
- 350mA (avg) Output Sink Current
- Reversed Supply Voltage Protection
- Build in Over Temperature Protection Function
- -20°C to 85°C Operating Temperature
- Low Profile TO-94 (SIP-4L) Package
- ESD Rating: 300V (Machine Model)

Applications

- Dual-Coil Brushless DC Motor
- Dual-Coil Brushless DC Fan
- Revolution Counting
- Speed Measurement



Figure 1. Package Type of AH276

COMPLEMENTARY OUTPUT HALL EFFECT LATCH

AH276

Pin Configuration

Z4 Package
(TO-94)

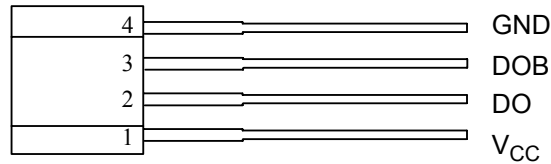

Figure 2. Pin Configuration of AH276 (Front View)

Pin Description

Pin Number	Pin Name	Function
1	V _{CC}	Supply voltage
2	DO	Output 1
3	DOB	Output 2
4	GND	Ground

COMPLEMENTARY OUTPUT HALL EFFECT LATCH

AH276

Functional Block Diagram

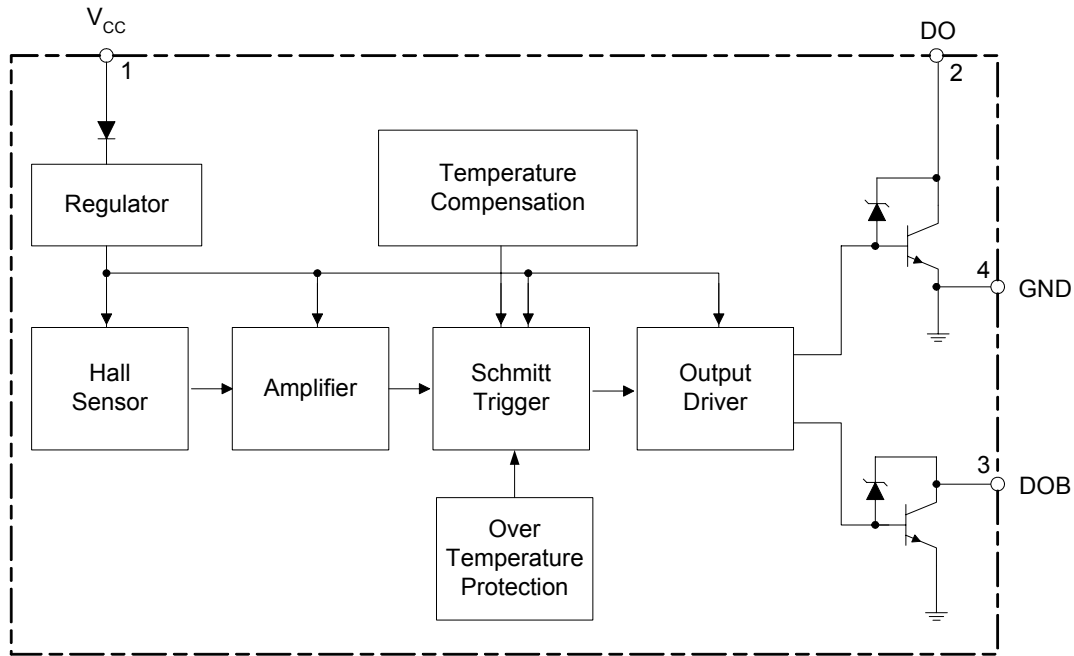
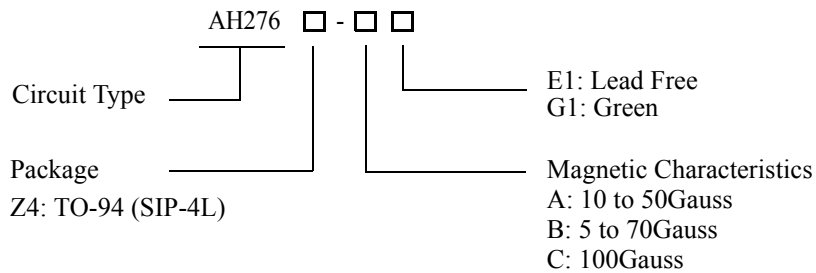

Figure 3. Functional Block Diagram of AH276

Ordering Information



Package	Temperature Range	Part Number		Marking ID		Packing Type
		Lead Free	Green	Lead Free	Green	
TO-94	-20 to 85 °C	AH276Z4-AE1	AH276Z4-AG1	AH276Z4-E1	AH276Z4-G1	Bulk
		AH276Z4-BE1	AH276Z4-BG1	AH276Z4-E1	AH276Z4-G1	Bulk
		AH276Z4-CE1	AH276Z4-CG1	AH276Z4-E1	AH276Z4-G1	Bulk

BCD Semiconductor's Pb-free products, as designated with "E1" suffix in the part number, are RoHS compliant. Products with "G1" suffix are available in green package.

**COMPLEMENTARY OUTPUT HALL EFFECT LATCH****AH276****Absolute Maximum Ratings (Note 1)** $(T_A=25^{\circ}\text{C})$

Parameter	Symbol	Value	Unit
Supply Voltage	V_{CC}	20	V
Reverse Protection Voltage	V_{RCC}	-20	V
Magnetic Flux Density	B	Unlimited	Gauss
Output Current	Continuous	350	mA
	Hold	550	mA
	Peak (start up)	750	mA
Power Dissipation	P_D	550	mW
Thermal Resistance	Die to atmosphere	θ_{JA}	227 $^{\circ}\text{C}/\text{W}$
	Die to package case	θ_{JC}	49 $^{\circ}\text{C}/\text{W}$
Storage Temperature	T_{STG}	-50 to 150	$^{\circ}\text{C}$
ESD (Machine Model)		300	V
ESD (Human Body Model)		2500	V

Note 1: Stresses greater than those listed under "Absolute Maximum Ratings" may cause permanent damage to the device. These are stress ratings only, and functional operation of the device at these or any other conditions beyond those indicated under "Recommended Operating Conditions" is not implied. "Absolute Maximum Ratings" for extended period may affect device reliability.

Recommended Operating Conditions $(T_A=25^{\circ}\text{C})$

Parameter	Symbol	Min	Max	Unit
Supply Voltage	V_{CC}	3.5	16	V
Ambient Temperature	T_A	-20	85	$^{\circ}\text{C}$



COMPLEMENTARY OUTPUT HALL EFFECT LATCH **AH276**

Electrical Characteristics

($T_A=25^{\circ}\text{C}$, $V_{CC}=14\text{V}$, unless otherwise specified)

Parameter	Symbol	Test Condition	Min	Typ	Max	Unit
Output Saturation Voltage	V_{SAT}	$V_{CC}=3.5\text{V}$, $I_O=100\text{mA}$		0.3		V
		$I_O=350\text{mA}$		0.35	0.6	V
Output Leakage Current	I_{OL}	$V_{CE}=16\text{V}$		0.1	10	μA
Supply Current	I_{CC}	$V_{CC}=16\text{V}$, Output Open		12	16	mA
Output Rise Time	t_r	$R_L=820\Omega$, $C_L=20\text{pF}$		3.0	10	μs
Output Fall Time	t_f	$R_L=820\Omega$, $C_L=20\text{pF}$		0.3	1.5	μs
Switch Time Differential	Δt	$R_L=820\Omega$, $C_L=20\text{pF}$		3.0	10	μs
Output Zener Breakdown Voltage	V_Z			55		V
Thermal Protection Temperature	TSD			178		$^{\circ}\text{C}$
Thermal Protection Hysteresis	ΔTSD			40		$^{\circ}\text{C}$

Magnetic Characteristics

($T_A=25^{\circ}\text{C}$)

Parameter	Symbol	Grade	Min	Typ	Max	Unit
Operating Point	B_{OP}	A	10		50	Gauss
		B	5		70	Gauss
		C			100	Gauss
Releasing Point	B_{RP}	A	-50		-10	Gauss
		B	-70		-5	Gauss
		C	-100			Gauss
Hysteresis	B_{HYS}			75		Gauss

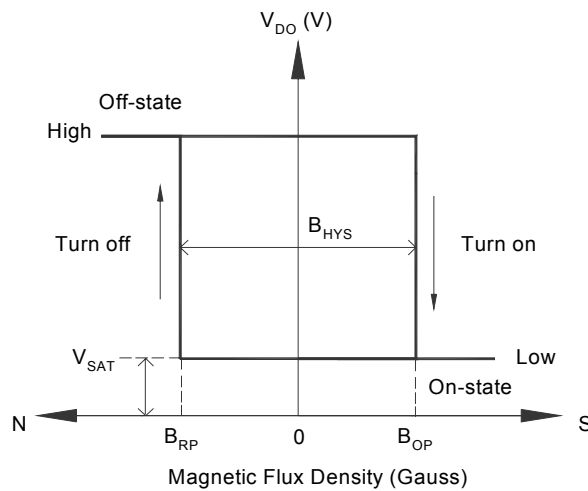

Magnetic Characteristics (Continued)

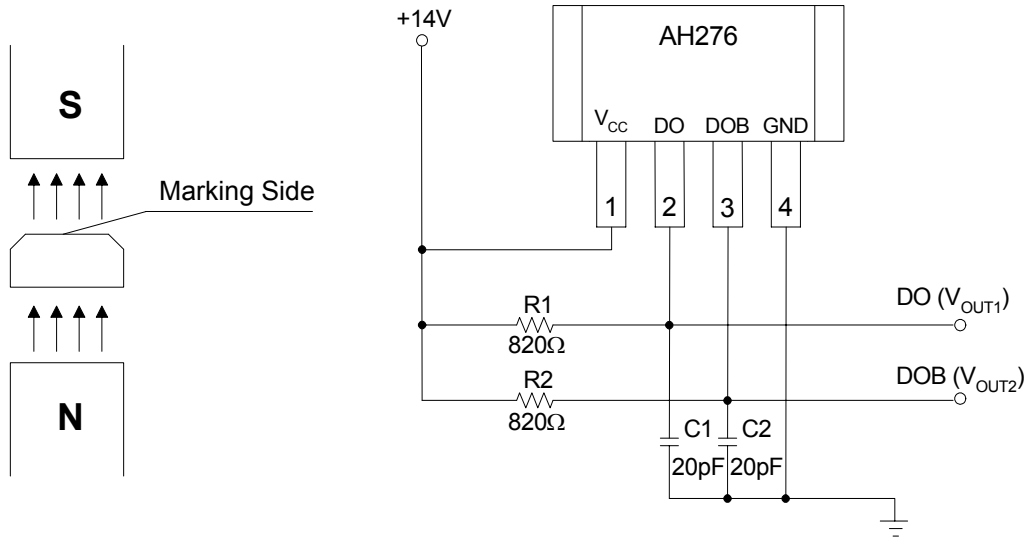

Figure 4. Basic Test Circuit

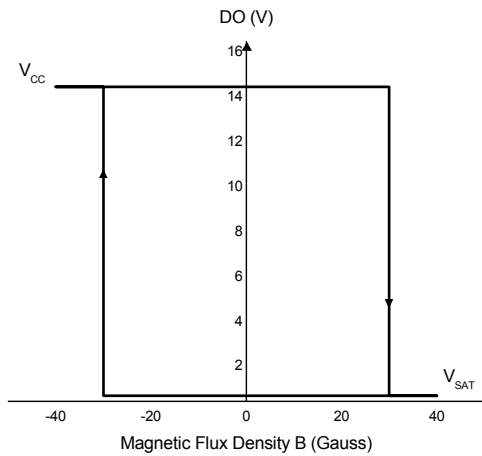

Figure 5. V_{DO} vs. Magnetic Flux Density

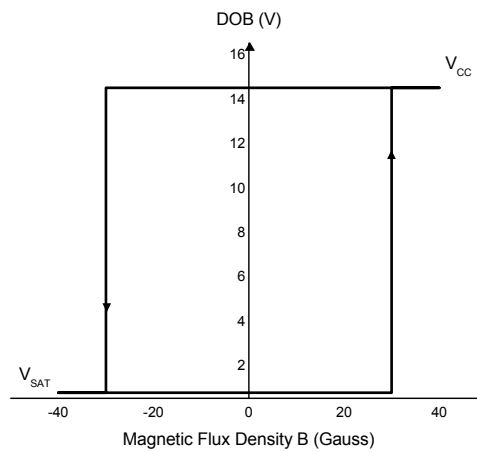

Figure 6. V_{DOB} vs. Magnetic Flux Density



COMPLEMENTARY OUTPUT HALL EFFECT LATCH

AH276

Typical Performance Characteristics

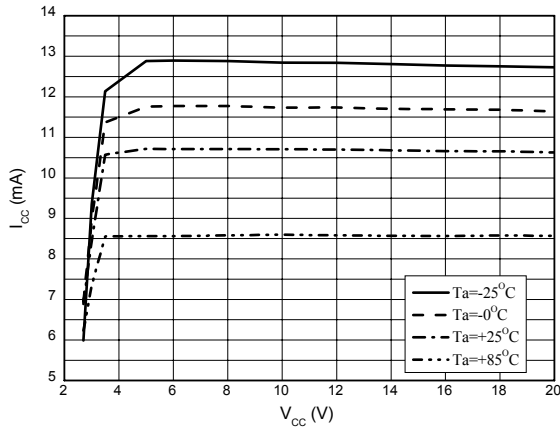

Figure 7. I_{CC} vs. V_{CC}

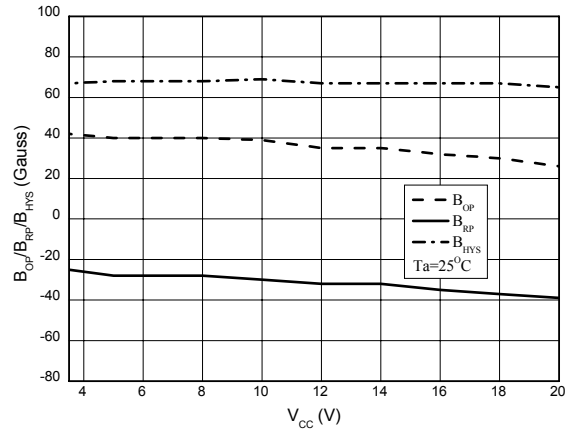

Figure 8. B_{OP}/B_{RP}/B_{HYS} vs. V_{CC}

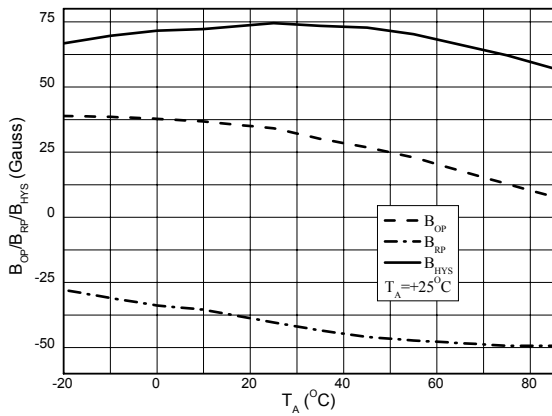

Figure 9. B_{OP}/B_{RP}/B_{HYS} vs. Ambient Temperature



Figure 10. P_D vs. Ambient Temperature

COMPLEMENTARY OUTPUT HALL EFFECT LATCH

AH276

Typical Performance Characteristics (Continued)

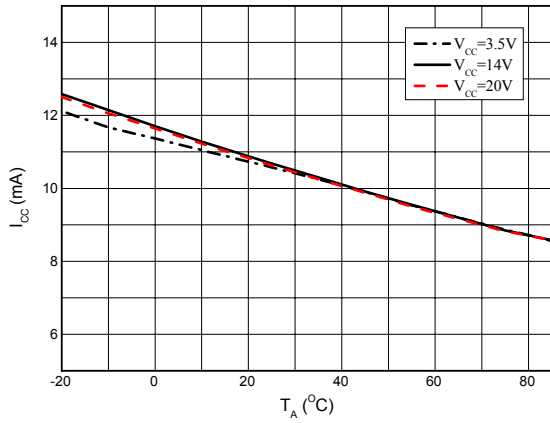

Figure 11. I_{CC} vs. Ambient Temperature

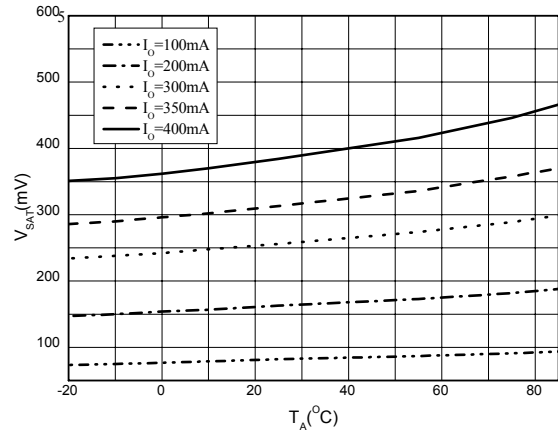

Figure 12. V_{SAT} vs. Ambient Temperature

Typical Applications

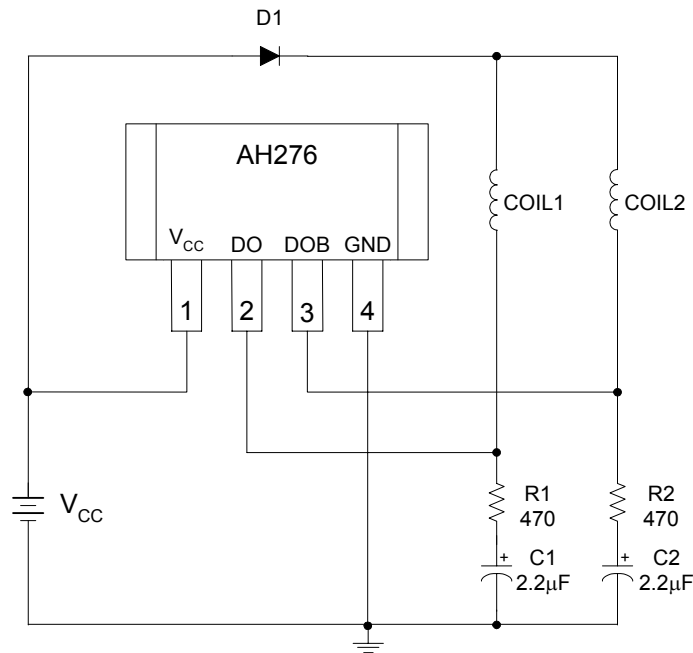

Figure 12. Typical Application Circuit



COMPLEMENTARY OUTPUT HALL EFFECT LATCH

AH276

Mechanical Dimensions

TO-94

Unit: mm(inch)

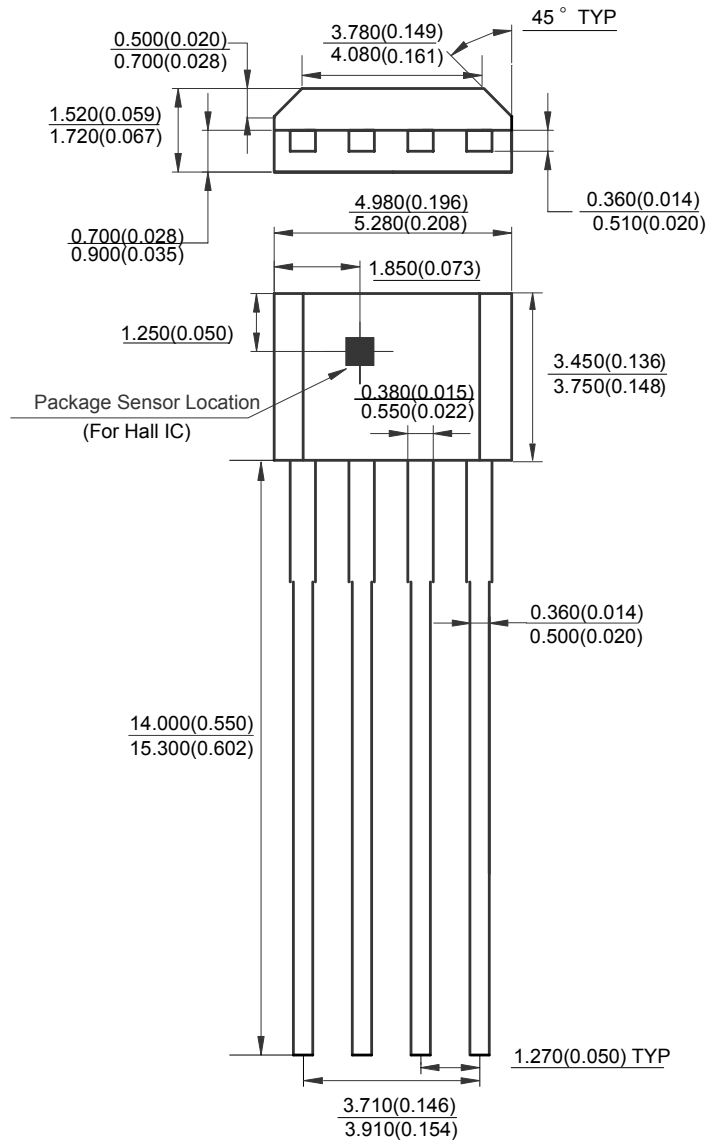



BCD Semiconductor Manufacturing Limited

<http://www.bcdsemi.com>

IMPORTANT NOTICE

BCD Semiconductor Manufacturing Limited reserves the right to make changes without further notice to any products or specifications herein. BCD Semiconductor Manufacturing Limited does not assume any responsibility for use of any its products for any particular purpose, nor does BCD Semiconductor Manufacturing Limited assume any liability arising out of the application or use of any its products or circuits. BCD Semiconductor Manufacturing Limited does not convey any license under its patent rights or other rights nor the rights of others.

MAIN SITE

- Headquarters

BCD Semiconductor Manufacturing Limited

No. 1600, Zi Xing Road, Shanghai Zizhu Science-based Industrial Park, 200241, China
Tel: +86-21-24162266, Fax: +86-21-24162277

- Wafer Fab

Shanghai SIM-BCD Semiconductor Manufacturing Co., Ltd.

800 Yi Shan Road, Shanghai 200233, China
Tel: +86-21-6485 1491, Fax: +86-21-5450 0008

REGIONAL SALES OFFICE

Shenzhen Office

Shanghai SIM-BCD Semiconductor Manufacturing Co., Ltd., Shenzhen Office

Unit A Room 1203, Skyworth Bldg., Gaoxin Ave. 1.S., Nanshan District, Shenzhen, China
Tel: +86-755-8826 7951
Fax: +86-755-8826 7865

Taiwan Office

BCD Semiconductor (Taiwan) Company Limited

4F, 298-1, Rui Guang Road, Nei-Hu District, Taipei, Taiwan
Tel: +886-2-2656 2808
Fax: +886-2-2656 2806

USA Office

BCD Semiconductor Corp.

30920 Huntwood Ave. Hayward, CA 94544, USA
Tel : +1-510-324-2988
Fax: +1-510-324-2788